

Article number: 03552090

Description: Fluro hydraulic rod end FPR 90N

Measures

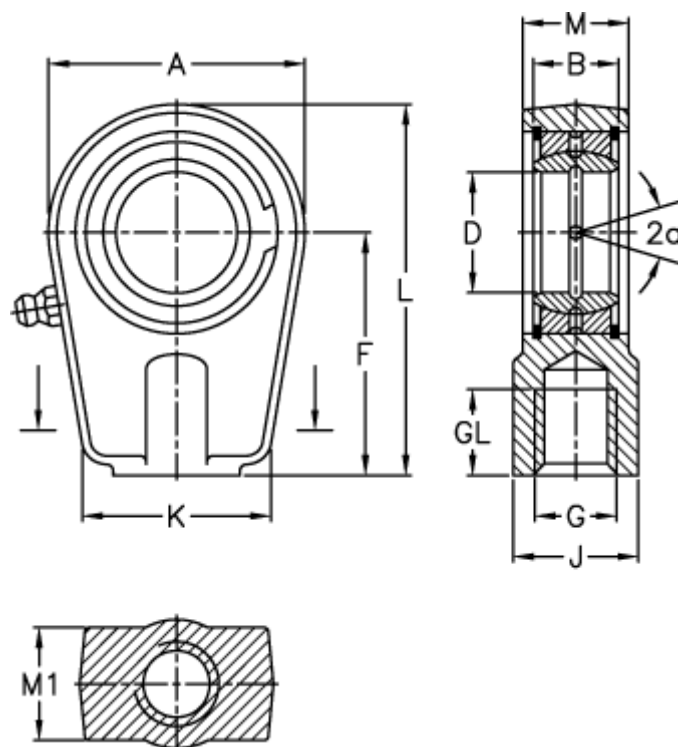

A	= 206	J	= 124
a (degrees)	= 5	K	= 180
B	= 60	L	= 323
D	= 90	M	= 65
Dynamic load C (kN)	= 490	M1	= 60
F	= 210	Static load C0 (kN)	= 980
g	= M100x2	Weight	= 19600
GL	= 101		